

**HANNOVER MESSE 2016**

**INDUSTRIAL  
SUPPLY  
SALON 5**

**TÜDÖKSAD KATILIMI**

**EKSTRA MALZEMELER**

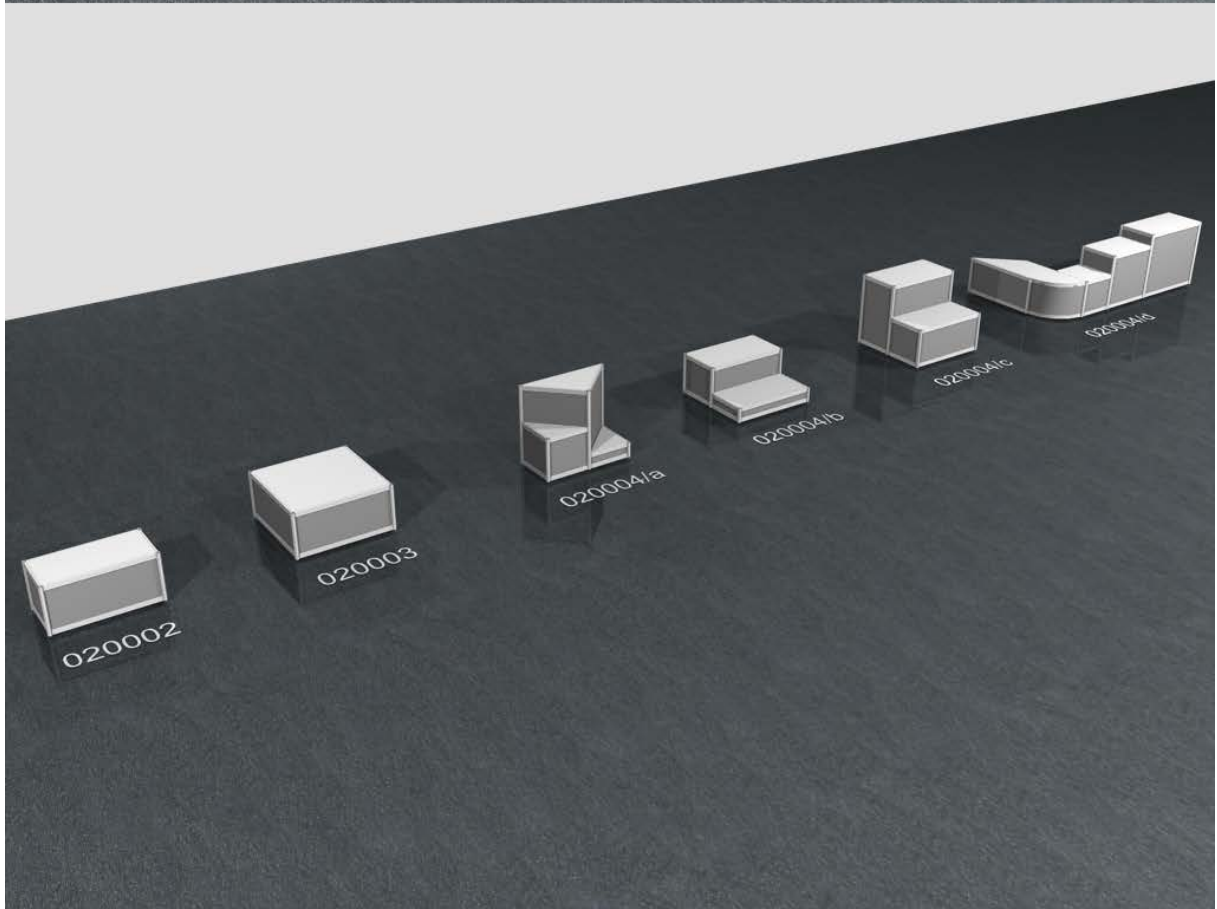
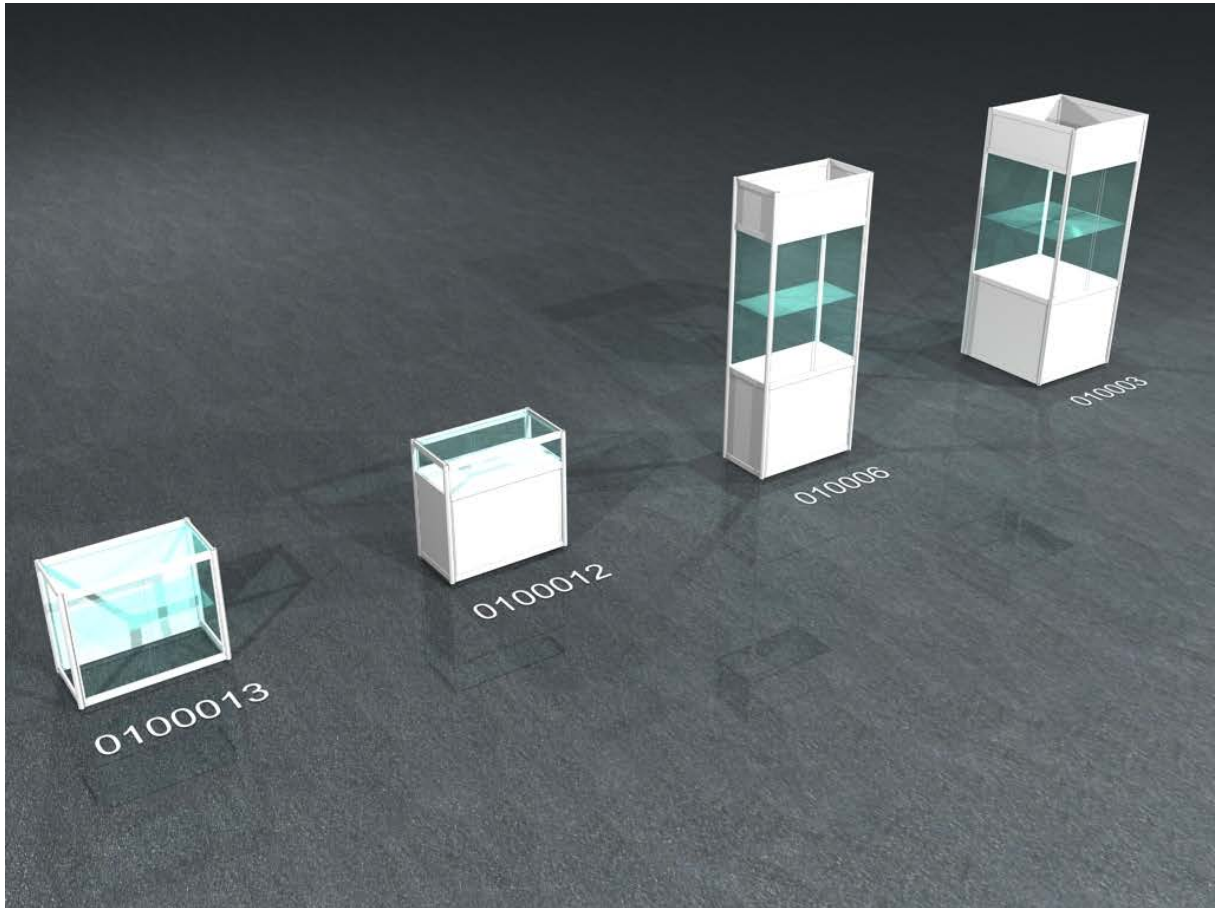

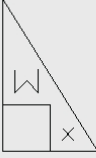
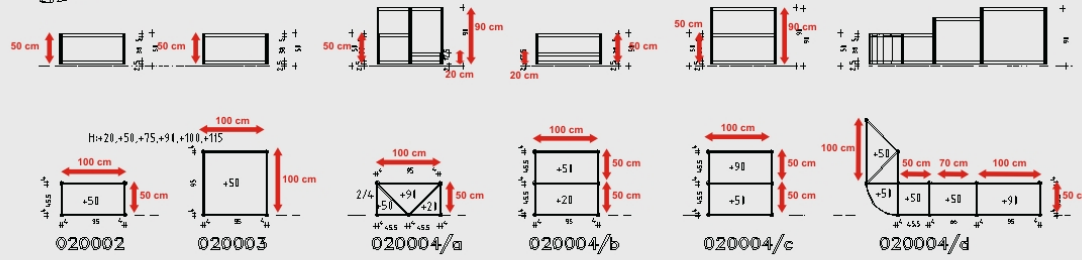
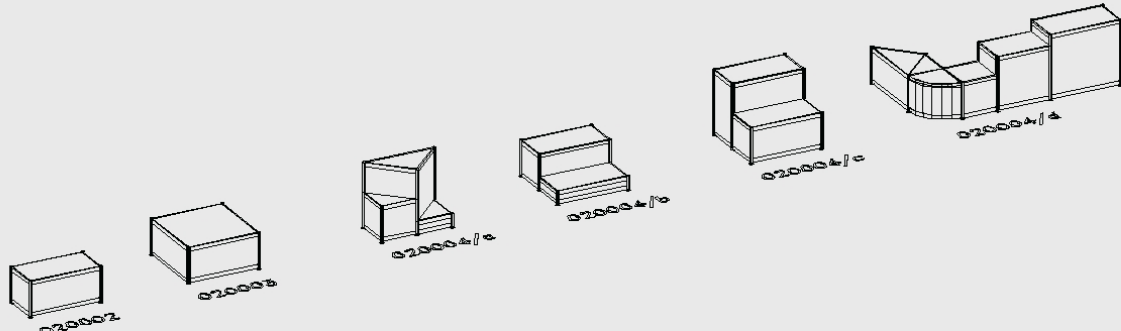

<p><b>MPI MESSEBAU &amp; DESIGN</b> K. Müller</p> <p>Sieglarweg, Straße 618 D-54105 KÖLN</p> <p>TEL: 00 49(0)221/850464, 00 49(0)221/850466 FAX: 00 49(0)221/850470</p>	Zeichnungs-Nr.	
	Projekt-Nr.	
	Mobil-Nr.	
	19975166	
Projekt	PODESTE	Geschnitten
System	OCTANORM	Erstellt am:
Firma:	MPI MESSEBAU & DESIGN GmbH	
Messe:	Datum:	Gesehen
Halle:	Stand:	Blatt:

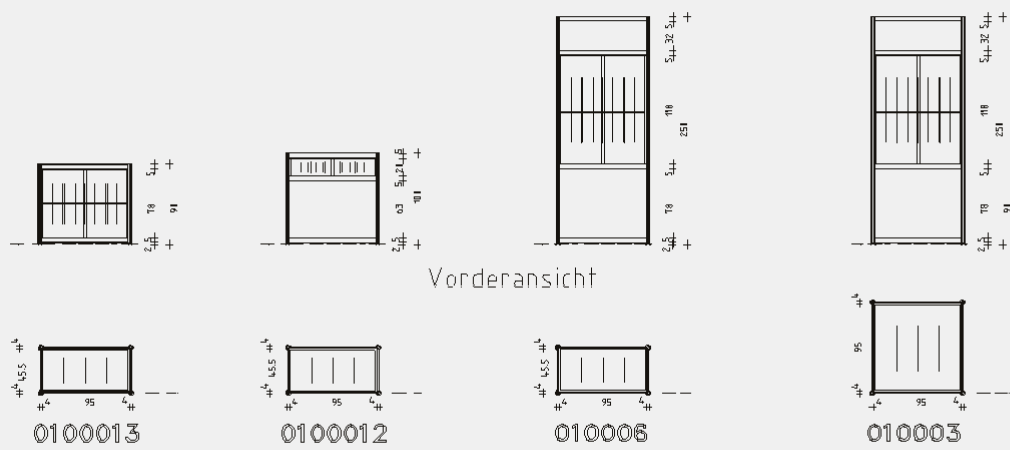

Vorderansicht

Draufsicht

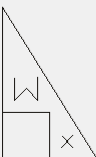

<p><b>MPI MESSEBAU &amp; DESIGN</b> K. Müller</p> <p>Sieglarweg, Straße 618 D-54105 KÖLN</p> <p>TEL: 00 49(0)221/850464, 00 49(0)221/850466 FAX: 00 49(0)221/850470</p>	Zeichnungs-Nr.	19975166
	Projekt-Nr.	975166
	Mobil-Nr.	
	Geschnitten	
Projekt	VITRINE	Erstellt am:
System	Octanorm	
Firma:	MPI MESSEBAU & DESIGN	
Messe:	Datum:	Gesehen
Halle:	Stand:	Blatt:

**HANNOVER MESSE 2016**  
**INDUSTRIAL SUPPLY**  
**TÜDÖKSAD KATILIMI**  
**SALON 5**  
**EKSTRA MALZEME SİPARİŞ FORMU**

**Firma Adı:** \_\_\_\_\_  
**Stand Numarası:** \_\_\_\_\_  
**Yetkili Kişi:** \_\_\_\_\_

**İstenen Alımlık Yazısı:** \_\_\_\_\_

**Tarih:** \_\_\_\_\_

ÜRÜN KODU	ÜRÜN ADI	BİRİM FİYAT	ÜCRETSİZ ADEDİ	ÜCRETLİ ADEDİ	TOPLAM BEDEL
0100013	Tam Camlı Vitrin	160 €			
0100012	Camlı Vitrin	160 €			
010006	Yüksek Camlı Vitrin	180 €	ÜCRETLİ		
010003	Büyük Camlı Vitrin	180 €	ÜCRETLİ		
020002	Platform	45 €			
020003	Platform	45 €			
020004/a	Platform	45 €			
020004/b	Platform	45 €			
020004/c	Platform	45 €			
020004/d	Platform	90 €	ÜCRETLİ		
Masa	Masa	31 €			
Sandalye	Sandalye	22 €			

	<b>ARA TOPLAM</b>
	<b>KDV (%18)</b>
	<b>TOPLAM</b>
	<b>FİRMA ADINA YETKİLİ KİŞİ İMZASI VE KAŞE</b>